

# ZAZA2 PLS3 New

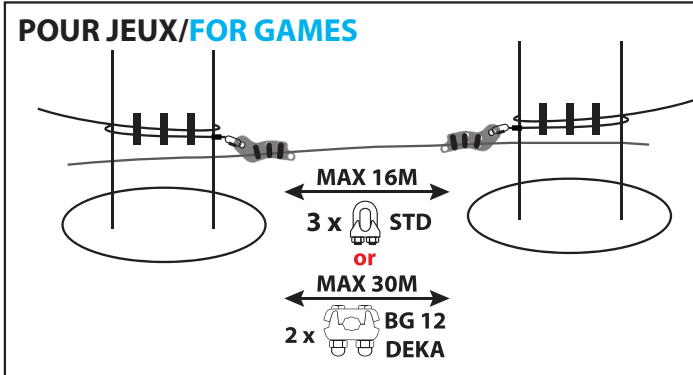

## AVANTAGES/ADVANTAGE

- Facile à installer/ Easy to install
- TOUS TYPE DE PARCOURS/ALL TYPE COURSE

**kN**  
CT/WLL 10kN

**CÂBLE DE SÉCURITÉ**  
SAFETY CABLE  
Ø 12  
or 1/2"  
ACIER/STEEL

**ADAPTABLE**  
STD 12  
ou  
BG 12 DEKA

**NORMES STANDARDS**  
EN 15567-1  
EN 13411-1/7

ACIER INOXYDABLE  
STAINLESS STEEL  
INOX 316 L

X1  
ZAZA2 PLS 3

=

X1  
GO 10/LO 7/16  
CT/WLL 1000KG

**ADAPTABLE**  
3X STD 12  
or  
2X BG 12 DEKA

**PLAQUE DE GUIDAGE INOX**  
GUIDING PLATE STAINLESS  
OBLIGATOIRE! MANDATORY!

**NO! Tyrolienne**  
**NO! Zipline**

**EXEMPLES DE SYSTEMES DE FIXATIONS**  
FIXATION EXAMPLE

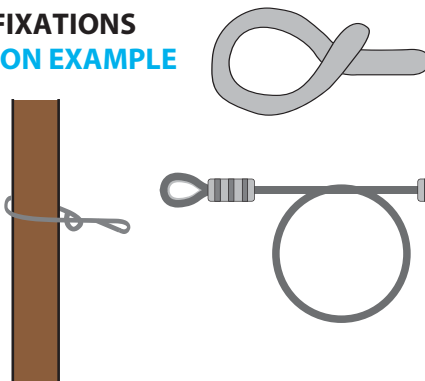

**ELINGUE RONDE TEXTILE TYPE "E"**  
ROUND TEXTILE SLING TYPE "E"

NORMES: EN 13411-1/7  
STANDARDS:

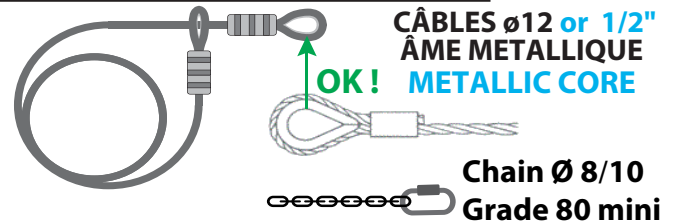

STD 12 = 25 Nm

BG 12 DEKA = 45 Nm

**OUTIL à SERTIR CRIMPER**  
x130 kN

EN15567-1  
EN13411-3  
STANDARDS  
ACCT

### Operation 1

OK



X1 GO10-LO7/16"

## NORMES DE MONTAGE STANDARDS OF ASSEMBLY



EN 15567-1  
EN 13411-1/7  
STANDARDS - ACCT

### Operation 2

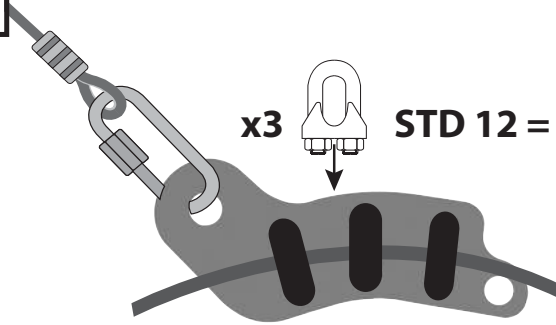

x3

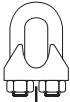

STD 12 = EN 13411-5



PLAQUE DE GUIDAGE OBLIGATOIRE!  
MANDATORY GUIDING PLATE !



STD 12 = 25 Nm

### Operation 2 BIS

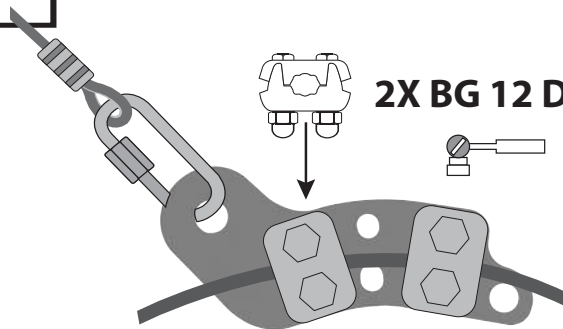

2X BG 12 DEKA =

= 45 Nm

Même sens de montage  
Same assembly direction

= OK!

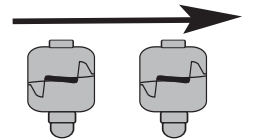

PLAQUE DE GUIDAGE OBLIGATOIRE!  
MANDATORY GUIDING PLATE !

### Operation 3

PLATINE DE DEPART  
STARTING PLATE

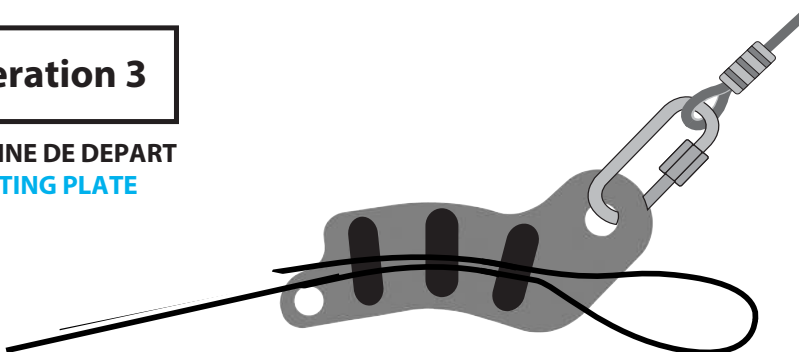

## NORMES DE MONTAGE STANDARDS OF ASSEMBLY



EN 15567-1:2015  
EN 13411-1/7  
STANDARDS - ACCT

# OBSERVE FITTING ORIENTATION OF BG CLAMPS

## OBSERVER LE SENS DE MONTAGE DES BG



= OBSERVE THE DIRECTION OF CIRCULATION OF THE SAFETY HOOK

= OBSERVER LE SENS DE CIRCULATION DU CROCHET

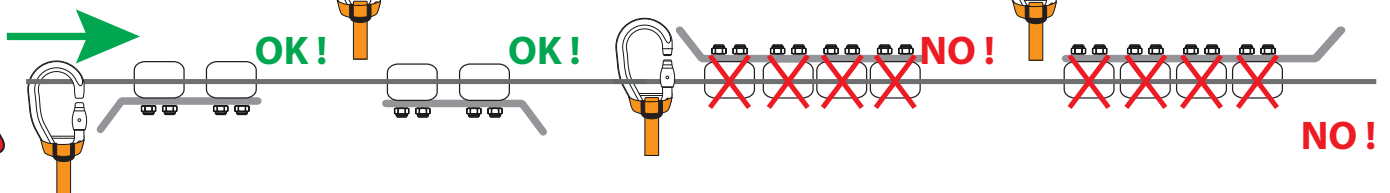
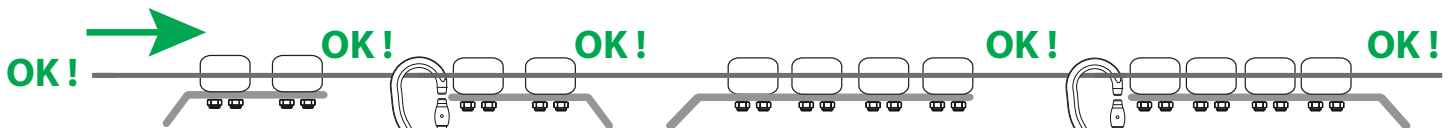
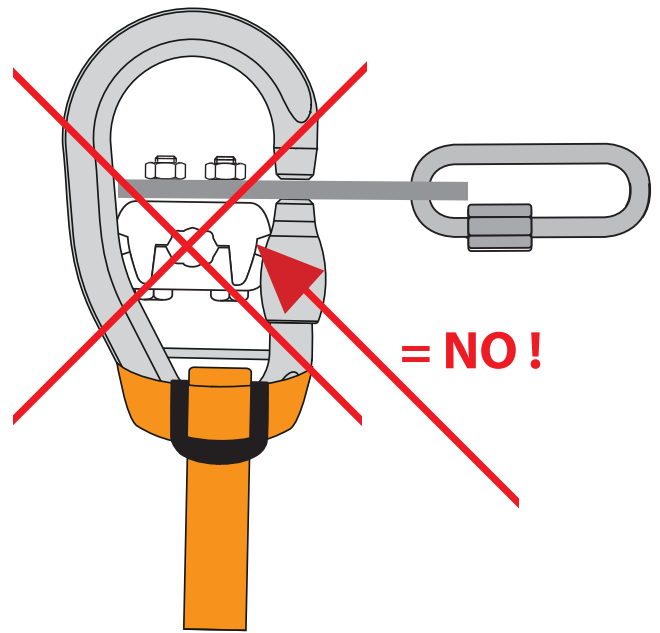
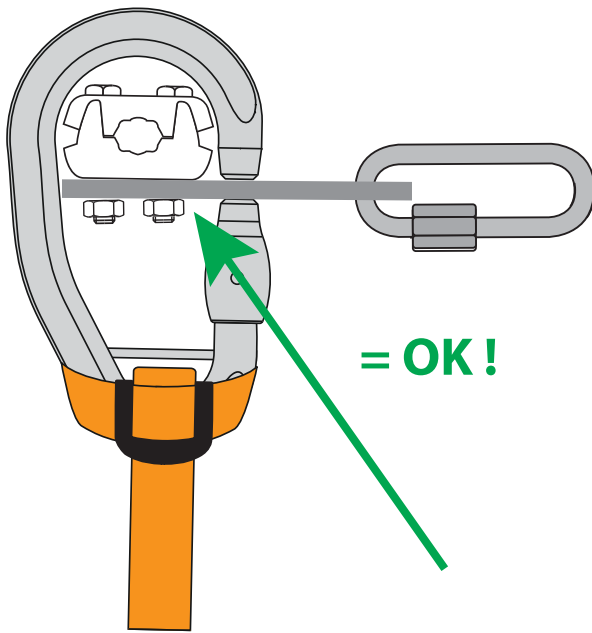
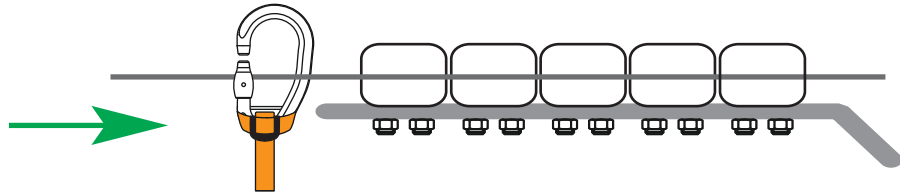

**Operation 4**

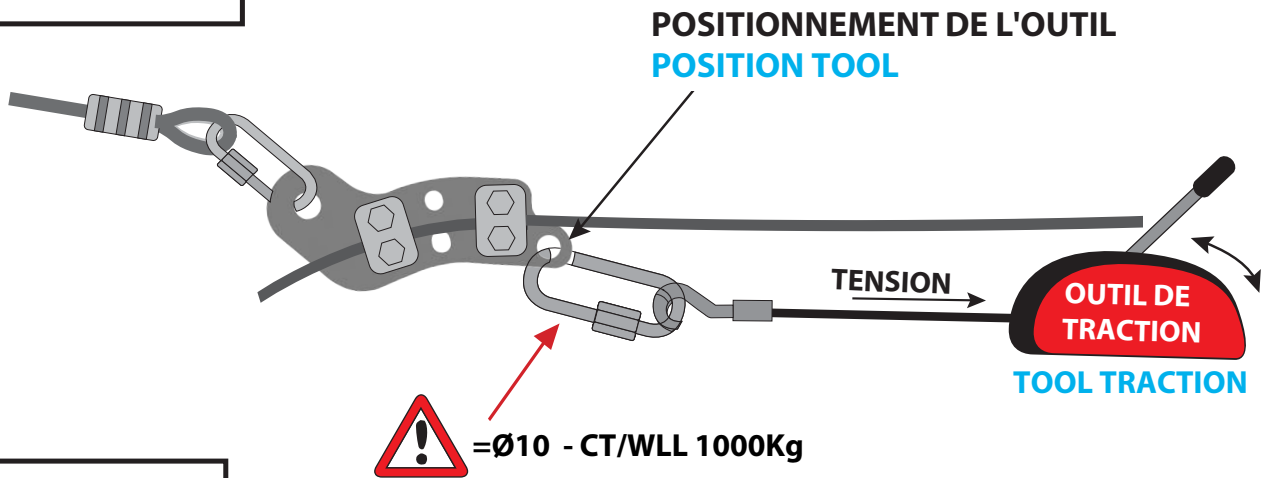

**Operation 5**

● RECOMMANDATION DE MONTAGE / RECOMMENDATION ASSEMBLY

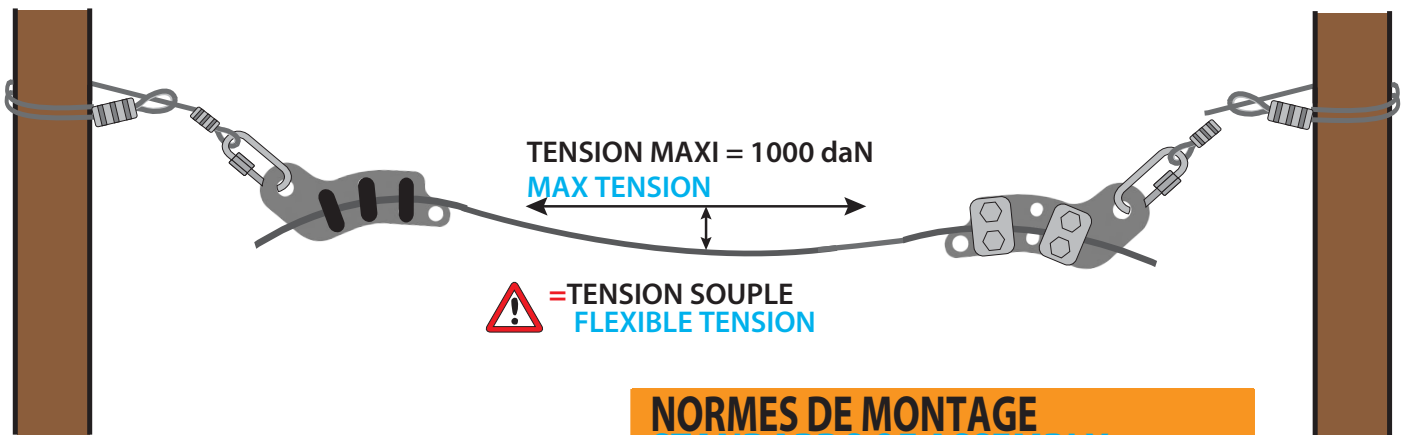

**NORMES DE MONTAGE**  
**STANDARDS OF ASSEMBLY**

EN 15567-1  
EN 13411-1/7  
STANDARDS - ACCT

**Operation 6**

● JONCTION  
JUNCTION

Exemples (non contractuel)  
de systèmes de fixations  
NOT Contractual examples  
system of fixing

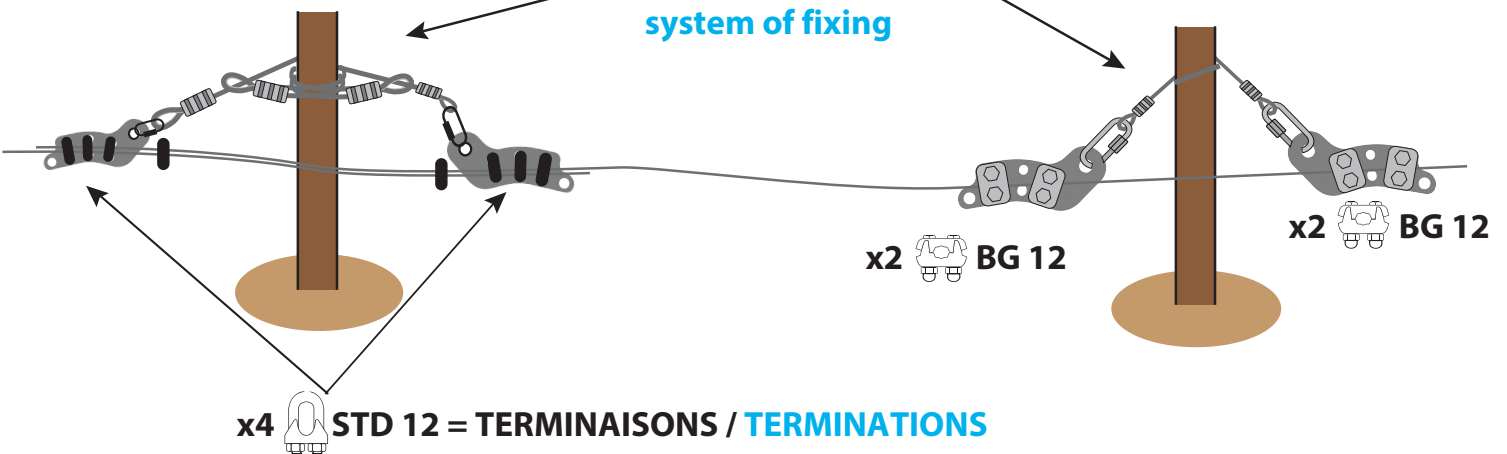

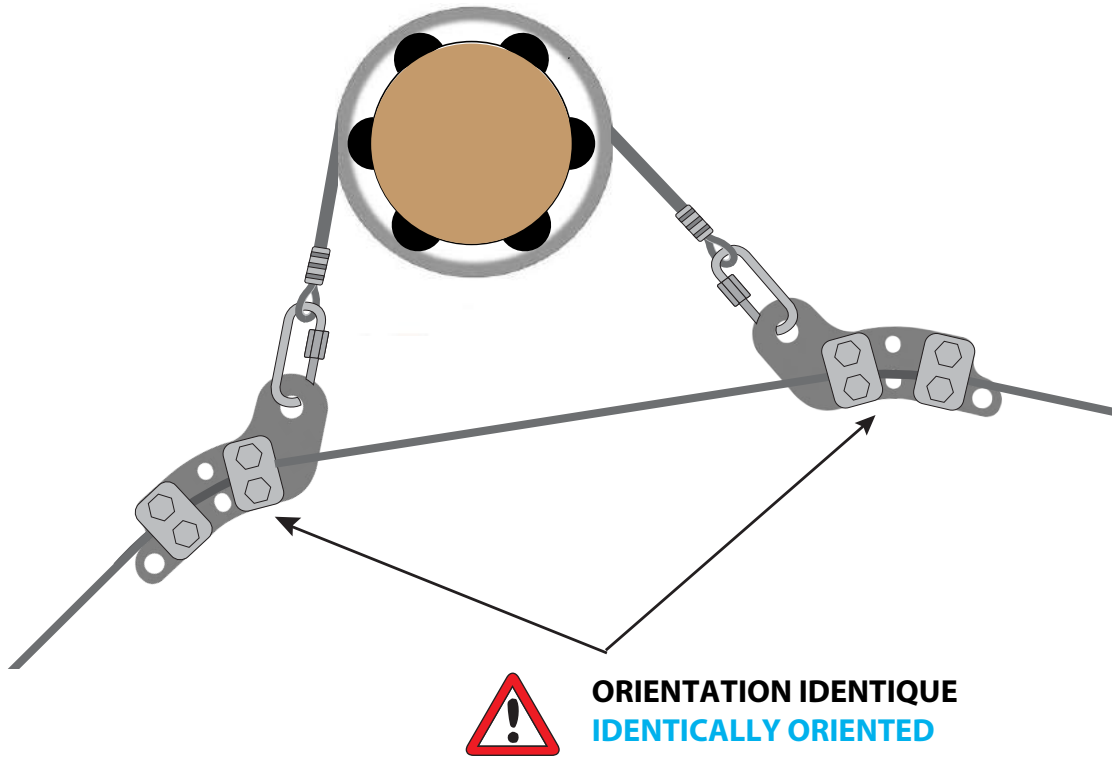

**Operation 7**

• **Montage pour jeux roulants** **Assembly for rolling games**

