

↑ ADJUST

Adjustable lanyard with steel buckle and textile handle, which allows adjusting a length under the tension.

DESCRIPTION



Big steel buckle for adjusting a length of the lanyard.

Identification label for product traceability.



Strong and durable 25 mm wide webbing.

Dural ring 28 mm

Eye with a protector for any EN362 connector.

Full strength textile handle for easy adjusting a length of the lanyard. Guaranteed safety of this loop in case of wrong attachment.

KEY FEATURES

-  adjustable length
-  anchor device
-  lanyard

STANDARDS

CE 1019
 EN 354: 10
 EN 795/B: 12
 EN 358: 18

FEATURES



one person only



length
80 cm- 145 cm



240 g / 8,5 oz







unique number



warranty

MATERIALS



-  93% polyester
-  3% Carbon steel
-  3% Al alloy
-  1% polyamid

TECHNICAL DATA

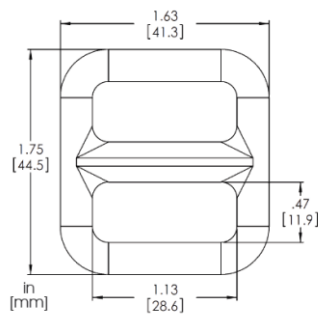

buckle dimensions

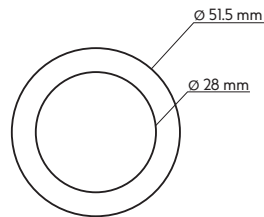

ring dimensions

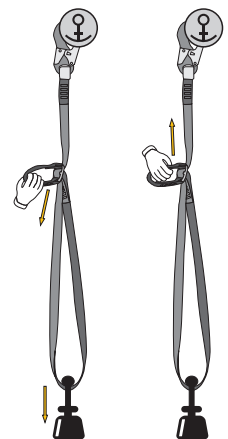

length adjustment procedure

