



3 year guarantee - Made in France

Specific information

OSCILLANTE

(EN) Pulley
(FR) Poulie
(DE) Seilrolle
(IT) Carrucola
(ES) Polea

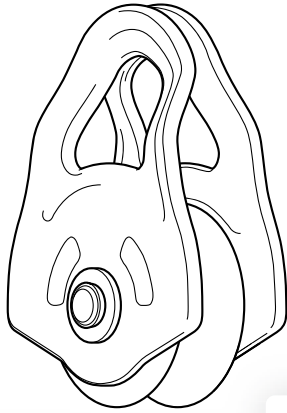

UIAA

CE 0082 EN12278

42 g

individually tested

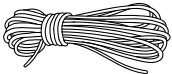

$7 \leq \varnothing \leq 11 \text{ mm}$



Tracability and Markings

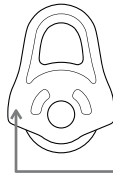

CE 0082

a. Body controlling the manufacture of this PPE

b. Notified body that carried out the CE type inspection

APAVE SUD Europe BP 193,
13322 Marseille Cedex 16
N°0082

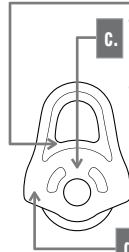

c. Traceability: datamatrix = product reference + individual number

d. Rope diameter

e. Individual number

00 000 A 0000

f. Year of manufacture

g. Day of manufacture

h. Control or name of inspector

i. Incrementation

1. Field of application

2. Nomenclature of parts

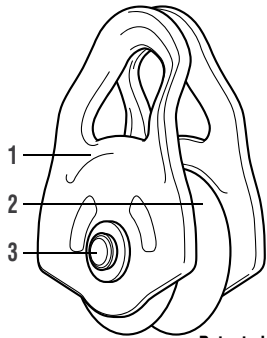

Patented

3. Inspection, points to verify

4. Compatibility

5. Values

5A. Working load limit
Valeur d'utilisation maxi
Maximale
Gebrauchslast
Valore d'utilizzo massimo
Valor de utilización máximo

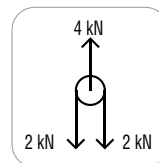
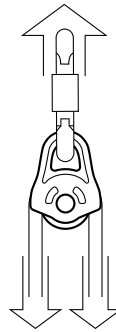

OK!

5B. Breaking load
Charge de rupture
Bruchlast
Carico di rottura
Carga de rotura

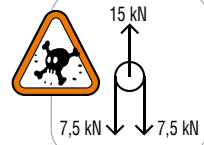
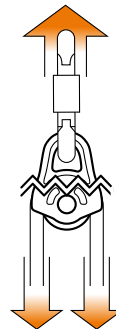

6. Pulley system efficiency

6A. Simple pulley system

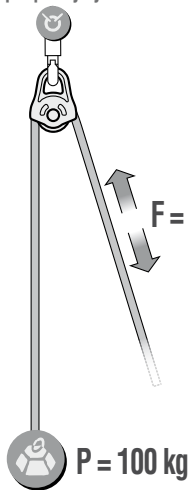

with progress capture

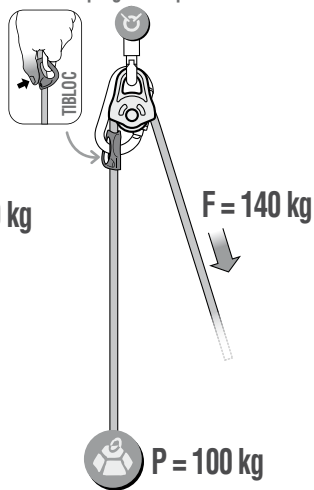

6B. 2:1 hauling system

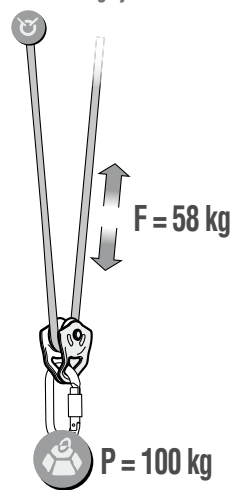

6C. 3:1 hauling system with progress capture

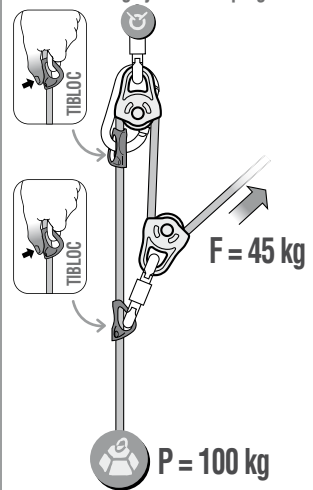

Theoretical force

$F = P$

$F = 0,5 P$

$F = 0,33 P$

$F = 1,4 P$

$F = 0,58 P$

$F = 0,45 P$

$F = 2 P$

$F = 0,66 P$

$F = 0,57 P$

7. Progress capture systems

TIBLOC + OSCILLANTE

Occasional use
Utilisation occasionnelle
Zur Aushilfe
Utilizzo occasionale
Utilización ocasional

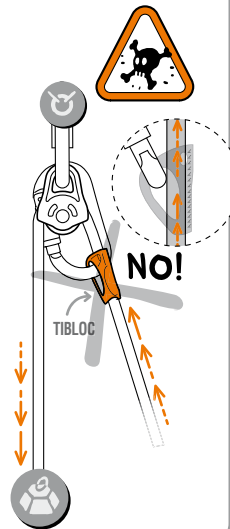
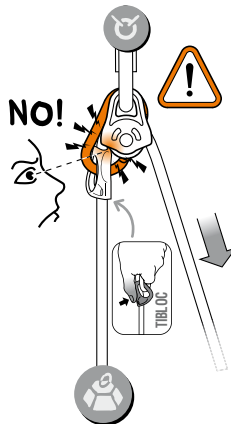
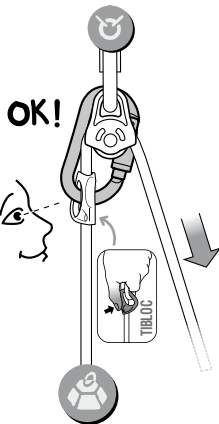
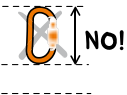
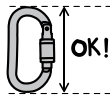

8. Positioning and redirection

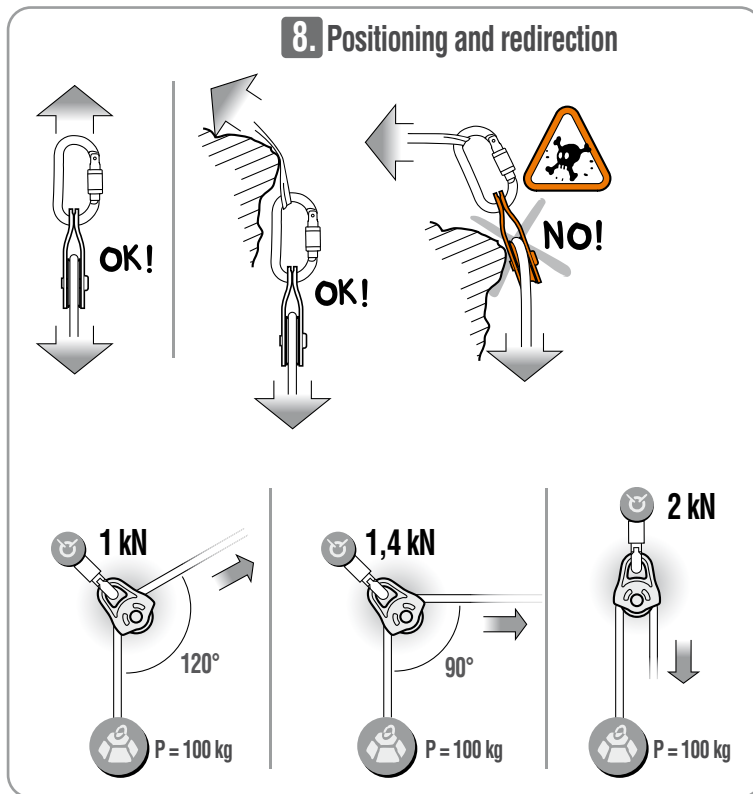

<p> + 80°C + 176°F - 40°C - 40°F </p> <p> (EN) Temperature (FR) Température (DE) Temperatur (IT) Temperatura (ES) Temperatura (PT) Temperatura (NL) Temperatuur (SE) Temperatur (FI) Lämpötila (NO) Temperatur </p> <p> (EN) Storage and transport (FR) Rangement et transport (DE) Lagerung und Transport (IT) Sistemazione e trasporto (ES) Almacenamiento y transporte (PT) Armazenamento e transporte (NL) Opbergen en vervoeren (FI) Säilytys ja kuljetus (NO) Lagring og transport (RU) Хранение и транспортировка (CZ) Skladování a doprava </p> <p> (PL) Pakowanie i transport (SI) Shranjevanje in transport (HU) Tárolás, szállítás (BG) Транспорти и съхранение (JP) 持ち運びと保管方法 (KR) 보관과 운송 (CN) 运输及储存 (TH) การขนส่งและกการเก็บรักษา </p>	<p> (RU) Температура (CZ) Teplota (PL) Temperatura (SI) Temperatura (HU) Hőmérséklet (BG) Температура (JP) 気温 (CN) 温度 (TH) อุณหภูมิ </p> <p> (EN) Cleaning/Disinfection (FR) Nettoyage/Désinfection (DE) Reinigung/Desinfektion (IT) Pulizia/Disinfezione (ES) Limpieza/Desinfección (PT) Limpeza/Desinfeção (NL) Reiniging/Ontsmetting (SE) Rengöring/Desinficering (FI) Puhdistus/Desinfiointi (NO) Rengjøring/Desinfisering (RU) Чистка/Дезинфекция </p> <p> (EN) Drying (FR) Séchage (DE) Trocknen (IT) Asciugamento (ES) Secado (PT) Secagem (NL) Het drogen </p> <p> (SE) Torkning (FI) Kuivaus (NO) Torking (RU) Сушка (CZ) Sušení (PL) Suszenie (SI) Sušenje </p> <p> (HU) Szárítás (BG) Сушене (JP) 乾燥 (CN) 使干燥 (TH) ทำให้งแห้ง </p>	<p> (EN) Maintenance (FR) Entretien (DE) Wartung (IT) Manutenzione (ES) Mantenimiento (PT) Manutenção (NL) Onderhoud (SE) Underhåll (FI) Huolehtiminen (NO) Vedlikehold </p> <p> (RU) Техническое обслуживание (CZ) Údržba (PL) Konserwacja (SI) Vzdrževanje (HU) Karbantartás (BG) Поддръжане (JP) メンテナンス (KR) (CN) 保养 (TH) การซ่อมแซม </p> <p> (EN) Dangerous products (FR) Produits dangereux (DE) Gefährliche Produkte (IT) Prodotti pericolosi (ES) Productos peligrosos (PT) produtos perigosos (NL) Gevaarlijke producten (SE) Farliga produkter (FI) Vaaralliset tuotteet (NO) Farlige produkter (RU) Опасная продукция </p> <p> (CZ) Nebezpečné výrobky (PL) Produkty niebezpieczne (SI) Nevarne kemikalije (HU) Veszélyes termékek (BG) Опасни продукти (JP) 有害物質 (KR) (CN) 危险品 (TH) วัตถุอันตราย </p>
--	---	--

Legends



- | | | |
|--------------------|-------------------------|-----------------|
| (EN) Anchor | (SE) Förankring | (SI) Sidrišče |
| (FR) Amarrage | (FI) Ankkuri | (HU) Fix pont |
| (DE) Anschlagpunkt | (NO) Forankring | (BG) Закрепване |
| (IT) Ancoraggio | (RU) Точка страховки | (JP) 支点 |
| (ES) Anclaje | (CZ) Ukotvení | (KR) 확보점 |
| (PT) Amarração | (PL) Punkt stanowiąkowy | (CN) 确定点 |
| (NL) Verankering | | (TH) สัมผัส |

PETZL
 ZI Cidex 105A
 38920 Crolles
 France
www.petzl.com/contact

ISO 9001
 Copyright Petzl